



En Euromof nos dedicamos al diseño y fabricación de muebles de oficina desde 1992. Líder en rapidez, calidad humana y servicio postventa. Gracias a nuestra experiencia en el sector, el continuo crecimiento de la empresa y un constante en el cumplimiento de los valores de calidad, hacen que Euromof destaque hoy entre los grandes fabricantes de mobiliario de oficina.

Disponemos de una gran infraestructura e instalaciones con sedes en Madrid y Toledo. Como marca consolidada, y gracias a nuestra extensa red de distribución, estamos presentes en todo el territorio nacional y desde hace años en los mercados internacionales, exportando nuestros productos a más de 20 países. Nuestra fábrica y almacenes de material en stock cuentan con una superficie superior a 15.500 metros cuadrados y nos permiten trabajar con plazos muy reducidos de entrega.

El compromiso con la naturaleza es otro de nuestros grandes valores. Fabricamos productos con una larga vida útil, susceptibles de mantenimiento, reparación y uso. Optimizando nuestras instalaciones, reduciendo el consumo de agua y energía, y establecido sistemas de reciclaje de residuos.

ÍNDICE

DIRECCIÓN



LOMA

6



VOLGA

12



SENDA

18



COLINA

24



ARMARIOS
DIRECCIÓN

30



MOSTRADOR ISLA

32



MOSTRADOR EURO

38

RECEPCIÓN

ÍNDICE

OPERATIVO



EURO 2000

42



EURO 3000

50



EURO 4000

56



EURO 5000

62



EURO 5100

70



MESAS DE REUNIÓN

76



CAJONERAS OPERATIVAS

80



ARMARIOS OPERATIVOS

82



MESAS MULTIFUNCIÓN

86



TELEMARKETING

88

COMUNES

LOMA

Se trata de una serie muy representativa de gran solidez y excelentes terminaciones. Loma crea ambientes exclusivos, respondiendo a todas las exigencias de funcionalidad y diseño en un despacho de dirección.

Is a very representative program of a great solidity and excellent finishes. Loma easily creates exclusive environments and meets all requirements of functionality and design in management office.



En Loma, los detalles son importantes. A sus atractivas y modernas terminaciones de color en bilaminado, se une la combinación del vidrio, que aporta elegancia y exclusividad. Las líneas rectas y los detalles metálicos realzan la imagen propia de la dirección de la empresa.

In Loma, the details are important. His attractive and modern color of bilaminate , combination of glass, brings elegance and exclusivity. Straight lines and metallic details enhance the image of the company 's presidency and direction.







- ① Tapa de mesa fabricada en bilaminado de 40mm.
40 mm bilaminate table top.
- ② Bases fabricadas en bilaminado de 60 mm.
Bases made of 60 mm bilaminate.
- ③ Pletinas de elevación de tapa en terminación platino.
Steel lid lifting plates with platinum finish.
- ④ Embellecedor en la parte inferior de las patas.
Metal trim down the bases.
- ⑤ Dos barras longitudinales metálicas bajo tapa.
Two metal longitudinal bars under cover.
- ⑥ Frontis de mesa de 19mm de espesor.
19 mm modesty panel.
- ⑦ Cantos de pvc de 2 mm redondeado radio 2.
Rounded pvc edge of 2 mm rounded radius 2.
- ⑧ Niveladores de suelo para regulación de altura.
Adjustable height with levelers.
- ⑨ Fondo de 900 mm.
Depth 900 mm.
- ⑩ Alto total 740 mm.
Height 740 mm.
- ⑪ Acabado en wengué y blanco.
Wengue and white finished.
- ⑫ Opción vade de vidrio 8 mm cajeado en tapa de mesa.
Optional glass writing surface made in 8mm .
- ⑬ Opción de añadir ala.
Optional side table.
- ⑭ Opciones de mesa de reunión a juego en diversos diseños.
Optional matching meeting table.
- ⑮ Opción de cajonera a juego con cerradura, cajón y archivo o tres cajones.
Two options of matchig drawer with lock.
- ⑯ Opción de añadir complementos de electrificación.
Optional electrification accessories.

Largo x Fondo x Alto / Length x Depth x Height

Mesa y ala / Table and wing

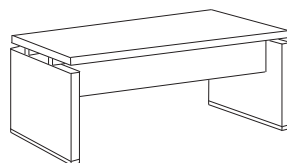

2000 x 900 x 740 mm
1800 x 900 x 740 mm

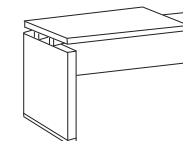

1020 x 600 x 740 mm

Mesas de reunión / Meeting tables

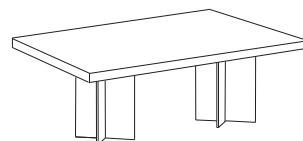

2400 x 1170 x 740 mm
2000 x 1000 x 740 mm

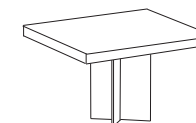

1170 x 1170 x 740 mm
(*) 1200 Ø c 740 mm

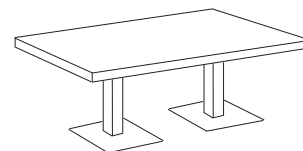

2400 x 1170 x 740 mm
2000 x 1000 x 740 mm

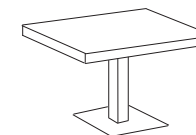

1170 x 1170 x 740 mm
(*) 1200 Ø c 740 mm

(*) Tambien disponible tapa redonda / Also available round table

Mesas de reunión modular / Modular meeting tables

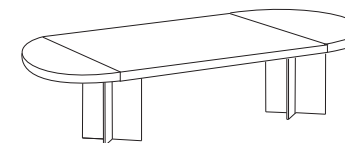
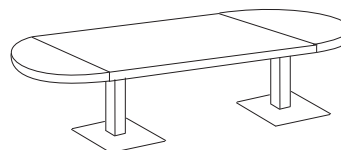

Consultar tamaños
Consultate the sizes



Blanco

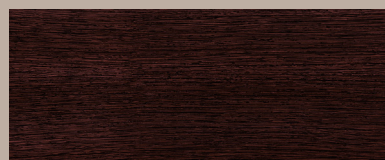

Wengué

VOLGA

En un nuevo concepto en mobiliario de dirección moderno, dinámico y actual.

Diseño exclusivo de sencillas líneas rectas. Aporta mucha personalidad gracias a su estructura cerrada de acero con terminación platino.

It is a new concept in modern, dynamic and contemporary furniture. Exclusive design, simple straight lines with a lot of personality thanks to its closed steel structure with platinum finish.









El objetivo es ofrecer un despacho diferente para trabajar y sentirse a gusto, esta combinación se refleja en Volga. Su secreto: diseño vistoso, elegante y liviano. Volga es el centro del despacho. Una serie contemporánea y exclusiva que cumple con las exigencias organizativas de los puestos de dirección.

The goal: to offer a different office to work and feel at ease, this combination is reflected in Volga. Its secret is its colorful, elegant and light design. Volga is the center of the office. A contemporary and exclusive series that meets the organizational requirements of management positions.

- ① **Tapa de mesa fabricada en bilaminado de 40mm.**
40 mm bilaminate table top.
- ② **Estructura cuadrada de acero con terminación platino.**
Square structure with platinum finished.
- ③ **Dos vigas longitudinales metálicas bajo tapa.**
Two metal longitudinal beams under cover.
- ④ **Cantos de pvc de 2 mm redondeado radio 2.**
Rounded Pvc edge of table top in 2 mm radius 2.
- ⑤ **Niveladores de suelo para regulación de altura.**
Adjustable height with levelers.
- ⑥ **Fondo de 900 mm.**
Depth 900mm.
- ⑦ **Alto total 740 mm.**
Height 740mm.
- ⑧ **Acabado en wengué y blanco.**
Wengue and white finished.
- ⑨ **Opción de añadir ala.**
Side table optional.
- ⑩ **Opciones de mesa de reunión a juego en diversos diseños.**
Optional matching meeting table in different sizes.
- ⑪ **Opción de cajonera a juego con cerradura, cajón y archivo o tres cajones.**
Two options of matchig drawer with lock.
- ⑫ **Frontis de mesa opcional en 19 mm.**
Optional 19 mm modesty panel.
- ⑬ **Opción de añadir complementos de electrificación.**
Optional electrification accessories.
- ⑭ **Opción de vidrio en tapa:**
Glass in table top options:
 - Con vade central cajeadado de vidrio de 6 mm.
With writing surface in 6 mm glass.
 - Bilaminado de 30 mm y vidrio de 6 mm en tapa completa.
30 mm bilaminate under and 6 mm glass.

Largo x Fondo x Alto / Length x Depth x Height

Mesa y ala / Table and wing

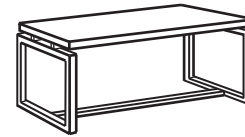

2000 x 900 x 740 mm
1800 x 900 x 740 mm

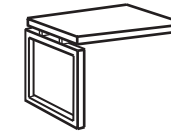

1020 x 600 x 740 mm

Mesas de reunión / Meeting tables

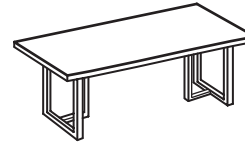

2400 x 1170 x 740 mm
2000 x 1000 x 740 mm



1170 x 1170 x 740 mm
(*) 1200 Ø c 740 mm

(*) Tambien disponible tapa redonda / Also available round table

Mesas de reunión modular / Mesas de reunión modular

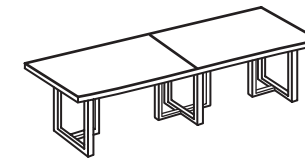
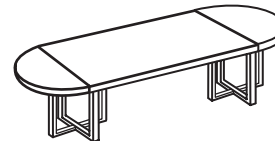

Consultar tamaños
Consulate the sizes

Detalle tapa vidrio + bilaminado / Glass + bilaminate top detail

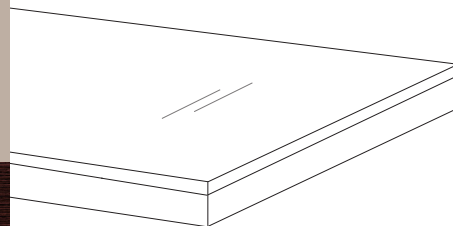

Opción tapa superior de mesa fabricada en bilaminado de 30 mm de grosor + vidrio de 6 mm blanco.

Top table top option made of 30 mm thick bilaminate + 6 mm white glass.

Blanco

Wengué

SENDA

Senda es una serie muy actual de líneas rectas. Se aplican conceptos de robustez con una fuerte y remarcada personalidad. Cuenta con gruesas tapas de bilaminado de alta calidad combinadas con sólidas bases y acabado platino.

Senda it's an actual program with straight lines, in which concepts of robustness with a strong personality are applied. It has thick high quality bilaminate tops combined with robust platinum finish bases.



“ Las cuatro bases metálicas con terminación platino permiten dotar de un estilo moderno cualquier despacho y zona de trabajo.”

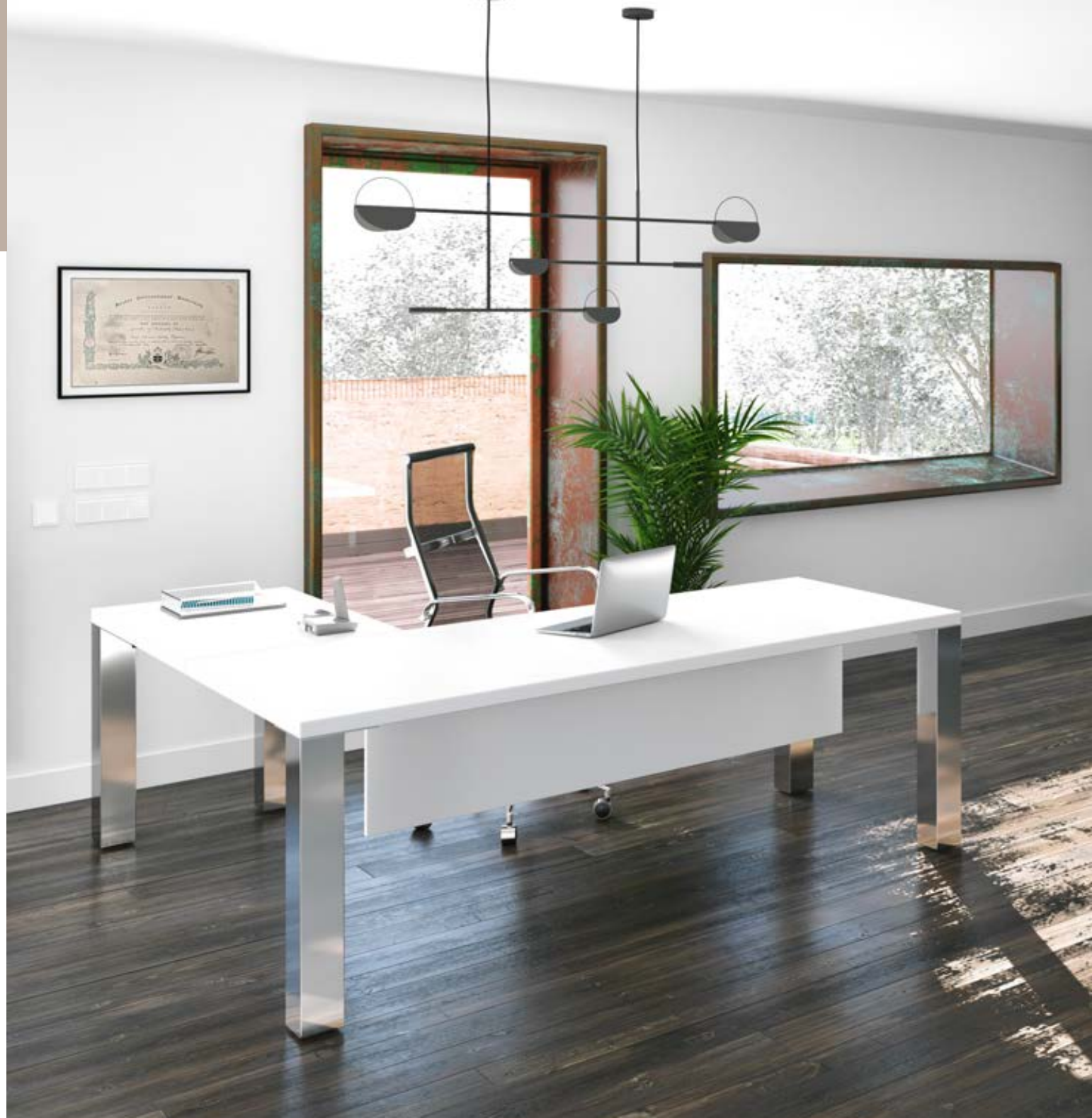



Las cuatro bases metálicas con terminación platino permiten dotar de un estilo moderno cualquier despacho y zona de trabajo.

En los nuevos entornos de trabajo, el diseño de la mesa de reunión adquiere gran importancia.

Senda dispone de amplias mesas iniciales y sucesivas con bases centrales remetidas para cubrir todas las necesidades en las salas de juntas.

"The four metal bases with platinum finish allow to give a robust and modern style any office and work area."

In the new work environments, the design of the meeting table acquires great importance.

Senda has large initial and successive tables with central bases tucked in to cover all the needs in the meeting rooms.



- ① Tapa de mesa fabricada en bilaminado de 40mm.
40 mm bilaminate table top.
- ② Patas de metal acabado platino de 100 x 100 x 700 mm.
100 x 100 x 700 platinum metal legs.
- ③ Dos vigas longitudinales metálicas bajo tapa para evitar arqueo.
Two metal longitudinal beams under cover.
- ④ Cantos de pvc de 2 mm redondeado radio 2.
Rounded Pvc edge of table top in 2 mm radius 2.
- ⑤ Niveladores de suelo para regulación de altura.
Adjustable height with levelers.
- ⑥ Fondo de 800 o 900 mm.
Depth 800 or 900mm.
- ⑦ Alto total 740 mm.
Height 740 mm.
- ⑧ Acabado en wengué y blanco.
Wengue and white finished.
- ⑨ Frontis de mesa opcional de 19mm de espesor.
Optional 19 mm modesty panel.
- ⑩ Opción tapa de vidrio 6 mm encima de el tablero de melamina.
Optional 6 mm glass table top on the bilaminate table top.
- ⑪ Opción de añadir ala.
Optional side table.
- ⑫ Opciones de mesa de reunión a juego en diversos diseños.
Optional matching meeting table.
- ⑬ Opción de cajonera a juego con cerradura, cajón y archivo o tres cajones.
Two options of matchig drawer with lock.
- ⑭ Opción de añadir complementos de electrificación.
Optional electrification accessories.

Largo x Fondo x Alto / Length x Depth x Height

Mesa y ala Table and wing

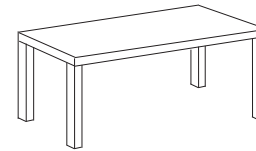

2000 x 900 x 740 mm
1800 x 900 x 740 mm
1600 x 800 x 740 mm

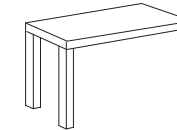

1020 x 600 x 740 mm

Mesas de reunión Meeting tables

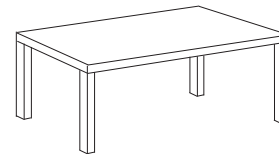

2400 x 1170 x 740 mm
2000 x 1000 x 740 mm

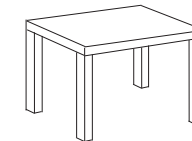

1170 x 1170 x 740 mm

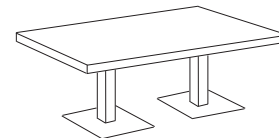

2400 x 1170 x 740 mm
2000 x 1000 x 740 mm

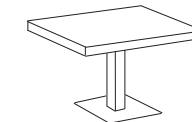

1170 x 1170 x 740 mm

Detalle tapa vidrio + bilaminado Glass + bilaminate top detail

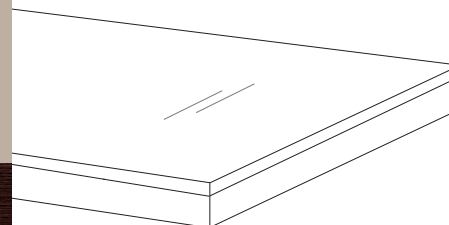

Opción tapa superior de mesa fabricada en bilaminado de 30 mm de grosor + vidrio de 6 mm blanco.

Top table top option made of 30 mm thick bilaminate + 6 mm white glass.



Blanco

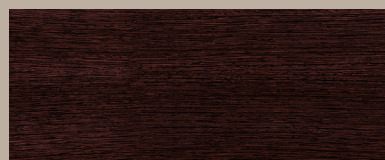

Wengué

COLINA

Es una serie de dirección con soluciones muy operativas. Colina se integra en las oficinas ofreciendo una decoración atemporal. Le caracteriza su altísima calidad dentro del segmento a un precio competitivo.

Management program with very operative solutions. Colina is integrated into the offices offering a timeless decoration. It is characterized high quality finishes within the melamine segment at a competitive price.





Su compacta estructura de panel cerrado y la moldura frontal, aportan a la serie Colina seriedad y distinción.

Las mesas de reunión guardan la misma elegancia de la serie. El diseño de peana central permite reunirse y trabajar con gran facilidad.

Its compact closed panel structure and front molding contribute to the Colina series, seriousness and distinction.

The meeting tables keep the same elegance of the series. The central base design allows meet and work easy.





- ① **Tapa de mesa fabricada en bilaminado de 30mm.**
30 mm bilaminate table top.
- ② **Moldura de DM de 10 mm en color gris y bilaminado de 30mm en frontal.**
Molding 10 mm grey DM + 30 mm bilaminate table top. in the front.
Moldura DM 10 mm en gris y bilaminado de 19mm en mesas de reunión.
Molding 10 mm grey DM + 19 mm bilaminate meeting tables.
- ③ **Bases en bilaminado de 30 mm.**
30 mm bilaminate base.
- ④ **Frontis de mesa de 19mm de espesor.**
19 mm modesty panel.
- ⑤ **Tapa de mesa con pasacables de serie.**
Grommet on the table top.
- ⑥ **Cantos de pvc de 2 mm redondeado radio 2.**
Rounded Pvc edge of table top in 2 mm radius 2.
- ⑦ **Niveladores de suelo para regulación de altura.**
Adjustable height with levelers.
- ⑧ **Fondo de 850 o 950 mm.**
Depth 850 or 950 mm.
- ⑨ **Alto total 740 mm.**
Height 740 mm.
- ⑩ **Opción de mesas rectangulares o doble arco.**
Optional rectangular or double arch tables.
- ⑪ **Opción de añadir ala.**
Optional side table.
- ⑫ **Opciones de mesa de reunión a juego en diversos diseños.**
Optional matching meeting table.
- ⑬ **Opción de cajonera a juego con cerradura, cajón y archivo o tres cajones.**
Two options of matchig drawer with lock.
- ⑭ **Opción de añadir complementos de electrificación.**
Optional electrification accessories.

Largo x Fondo x Alto / Length x Depth x Height

Mesa y ala / Table and wing

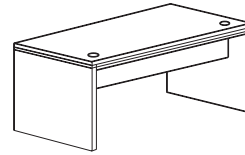

2000 x 800 x 740 mm
1800 x 800 x 740 mm
1600 x 800 x 740 mm
1400 x 800 x 740 mm
1200 x 800 x 740 mm

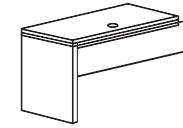

1020 x 600 x 740 mm

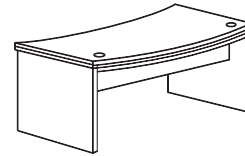

2000 x 850 - 950 x 740 mm
1800 x 850 - 950 x 740 mm

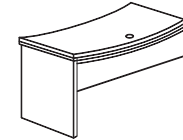

1140 x 580 - 640 x 740 mm

Mesas de reunión / Meeting tables

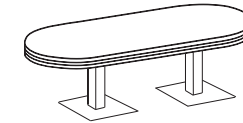
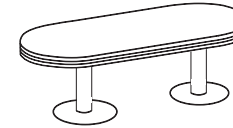
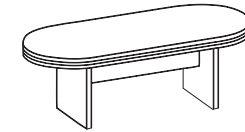

2400 x 1000 x 740 mm
2000 x 900 x 740 mm

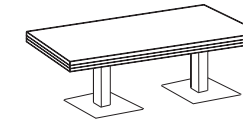
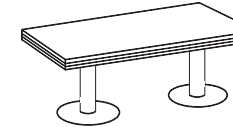
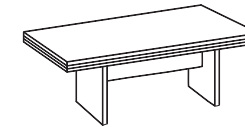

2400 x 1000 x 740 mm
2000 x 1000 x 740 mm

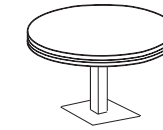
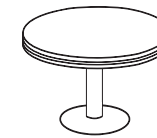

1200 Ø c 740 mm
1000 Ø c 740 mm

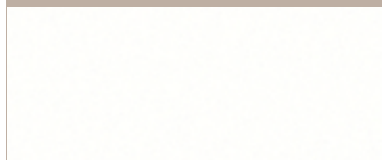

Blanco

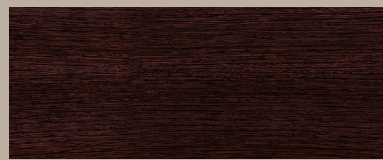

Wengué



Roble



Haya



Gris

ARMARIOS DIRECCIÓN



- ① Encimera de bilaminado de 30mm.
30 mm bilaminate worktop.
- ② Trasera de bilaminado de 10mm.
10 mm bilaminate rear.
- ③ Laterales, suelo y puertas de bilaminado en 19 mm.
Sides, floor and doors bilaminate 19 mm.
- ④ Cerradura metálica con falleba en puertas verticales de bilaminado.
Metallic lock with bolts on vertical bilaminate doors.
- ⑤ Puertas de cristal matizado sin marco de 6 mm.
6 mm tinted glass doors without frame.
- ⑥ Bisagras automáticas, provistas de regulación.
Automatic hinges, equipped with regulation.
- ⑦ Canto de tapa redondeado en radio 2 mm.
Rounded edge of table top in 2 mm.
- ⑧ Canto puertas y frentes de archivo redondeado en radio 1 mm.
Rounded edge of doors in 2 mm.
- ⑨ Cuatro niveladores de suelo en cada armario.
Four floor levelers in each cupboard.
- ⑩ Disponible en tres tamaños de altura.
Available in three sizes.
- ⑪ Largo total 470, 920 o 1500 mm.
Length 920 or 1500 mm.
- ⑫ Fondo de 420 mm.
Depth 920 or 1500 mm.
- ⑬ Envoltente en bilaminado de 40 mm.
Optional enclosures at 40 mm bilaminate.
- ⑭ Dos opciones de estantes: Normal con 19 mm o sobrecarga con 30 mm.
Two options of shelves: Normal with 19 mm or overload with 30 mm.
- ⑮ Opción de añadir tirador cromado.
Optional chrome handle.
- ⑯ Opción de añadir soporte fijo o telescópico para carpetas.
Option to add permanent or telescopic support for folders.

Armarios / Wardrobe

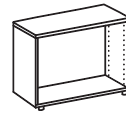

920 x 420 x 740 mm

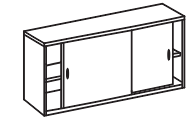
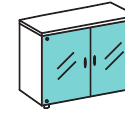

1500 x 420 x 740 mm

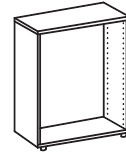

920 x 420 x 1400 mm

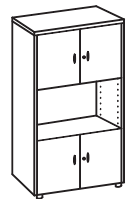
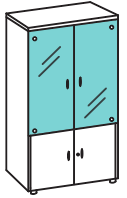
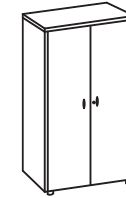
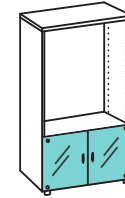
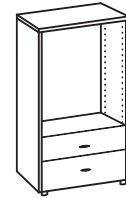
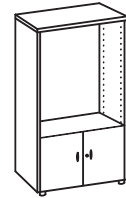
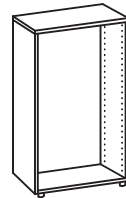
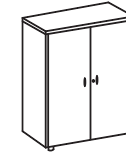
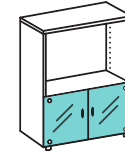

920 x 420 x 2060 mm

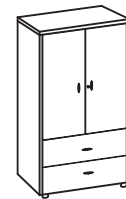
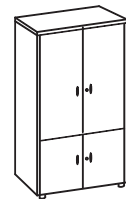

Envoltentes / Enclosures

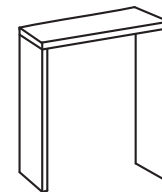
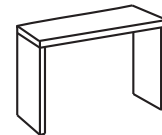
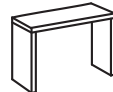

1000 x 420 x 760 mm

1000 x 420 x 1420 mm

1000 x 420 x 2080 mm

1470 x 420 x 760 mm

1470 x 420 x 1420 mm

1470 x 420 x 2080 mm

1920 x 420 x 760 mm

1920 x 420 x 1420 mm

1920 x 420 x 2080 mm

2390 x 420 x 760 mm

2390 x 420 x 1420 mm

2390 x 420 x 2080 mm

2840 x 420 x 760 mm

2840 x 420 x 1420 mm

2840 x 420 x 2080 mm

Blanco

Wengué

ISLA

Recepción de alta calidad. Isla cumple con éxito el objetivo de convertirse en la primera cara visible de cualquier empresa.

Es un mostrador totalmente modular y adaptable a cualquier entorno.

High quality reception. Isla successfully meets the goal of becoming the first visible face of any company.

It is a fully modular counter and adaptable to any environment.



RECEPCIÓN







- ① Encimera, tapa de mesa y laterales fabricados en tablero de 30 mm.
Table top, worktable and sides made in 30 mm.
- ② Encimera de bilaminado 30 mm o de vidrio matizado 6+6 mm.
Table top in bilaminate or 6+6 glass.
- ③ Tapa de mesa con pasacables de serie.
Grommet on the table top.
- ④ Laterales de bilaminado en 30 mm, color gris perla.
30 mm grey bilaminate sides.
- ⑤ Frontal de mostrador partido en cuatro piezas de 19 mm, curvas o rectas.
Front panel in four pieces.
- ⑥ Módulos rectos y en esquina.
Modules straight and corner.
- ⑦ Tapa de mesa con pasacables de serie.
Grommet on the table top.
- ⑧ Cantos de pvc de 2 mm redondeado radio 2.
Rounded Pvc edge of table top in 2 mm radius 2.
- ⑨ Niveladores de suelo para regulación de altura.
Adjustable height with levelers.
- ⑩ Fondo de 790 mm.
Depth 790 mm.
- ⑪ Alto total 1100 mm.
Height 1100 mm.
- ⑫ Acabado en blanco, gris y wengué.
White, grey or wengue finished.
- ⑬ Opción de cajonera a juego con cerradura, cajón y archivo o tres cajones.
Optional matchig drawer with lock.
- ⑭ Opción de añadir complementos de electrificación.
Optional electrification accessories.

* El frontal de los elementos curvos sólo se puede fabricar en wengué y gris.

* The front of the curved elements could be made in wengue or grey.

Largo x Fondo x Alto / Length x Depth x Height

Módulos Mostrador / Counter Modules

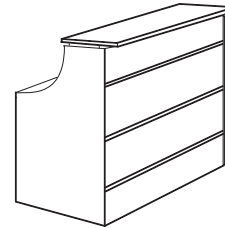

2000 x 790 x 1100 mm
1800 x 790 x 1100 mm
1600 x 790 x 1100 mm
1400 x 790 x 1100 mm
1200 x 790 x 1100 mm
800 x 790 x 1100 mm

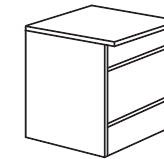

800 x 790 x 740 mm

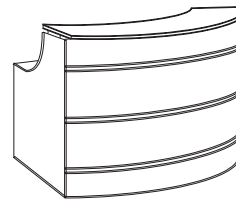

1920 x 940 x 1100 mm
(Módulo curvo 26°)

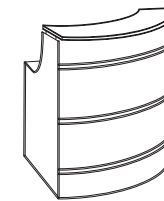

1300 x 1300 x 1100 mm
(Módulo curvo 90°)

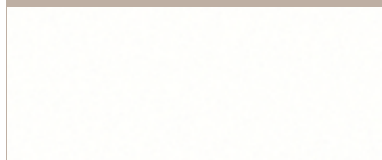

Blanco

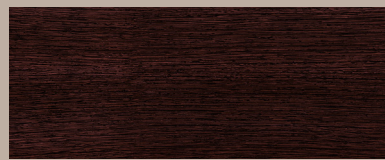

Wengué



Gris

EURO

Mostrador de recepción operativo, diseñado para crear espacios de trabajo independientes y de atención al cliente. Son módulos funcionales de líneas rectas, acorde a la tendencia actual, modernos y de calidad.

Operative reception desk, designed to create independent workspaces and customer service. They are functional modules of straight lines, according to the current trend, modern and of quality.





Solución eficaz a necesidades de atención al cliente, mostrador, recepción, información, punto de venta... Con grandes opciones de personalizar en forma y color. El doble cerramiento lateral, permite que los módulos sean totalmente independientes, pudiéndolos combinar de forma sencilla con otros para crear amplias recepciones multipuesto.



Effective solution to needs of customer service, counter , reception, point of sale... With great options to customize in many forms and colours. The double lateral enclosure, allows the modules to be totally independent, being able to combine them with other modules to create large multi-user receptions.

- ① **Tablero bilaminado de 30 mm de grosor en laterales y tapa de mesa.**
Worktable and sides made in 30 mm bilaminate.
- ② **Encimera de bilaminado 30 mm o de vidrio matizado 6+6 mm.**
Table top in bilaminate or 6+6 glass.
- ③ **Tapa de mesa con pasacables de serie.**
Grommet on the table top.
- ④ **Dos embellecedores de color gris en el frontal del mostrador.**
Two grey trims in the front.
- ⑤ **Módulos rectos y en esquina.**
Modules straight and corner.
- ⑥ **Tapa de mesa con pasacables de serie.**
Grommet on the table top.
- ⑦ **Cantos de pvc de 2 mm redondeado radio 2, en frontis 1 mm.**
Rounded Pvc edge of table top in 2 mm radius 2, modesty panel in 1 mm.
- ⑧ **Niveladores de suelo para regulación de altura.**
Adjustable height with levelers.
- ⑨ **Fondo de 790 mm.**
Depth 790 mm.
- ⑩ **Alto total 1100 mm.**
Height 1100 mm.
- ⑪ **Opción de cajonera a juego con cerradura, cajón y archivo o tres cajones.**
Optional matchig drawer with lock.
- ⑫ **Opción de añadir complementos de electrificación.**
Optional electrification accessories.

Largo x Fondo x Alto / Length x Depth x Height

Módulos Mostrador / Counter modules

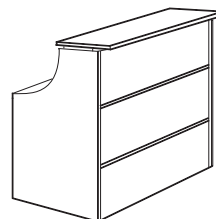

2000 x 790 x 1100 mm
1800 x 790 x 1100 mm
1600 x 790 x 1100 mm
1400 x 790 x 1100 mm
1200 x 790 x 1100 mm
800 x 790 x 1100 mm

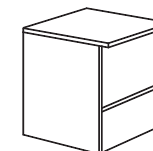

800 x 790 x 740 mm

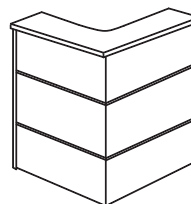

1090 x 1090 x 1100 mm
820 x 820 x 1100 mm

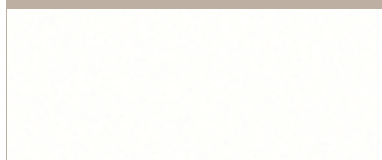

Blanco

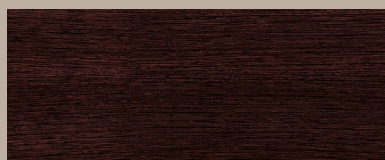

Wengué



Roble



Haya



Gris

EURO 2000

Serie operativa que por sí misma da soluciones a todas las necesidades de una oficina actual. Se caracteriza por su altísima calidad dentro del segmento a un precio competitivo.

Operational series that by itself provides solutions to all the needs of a current office. It's very high quality in the melamine segment at a competitive price.



Euro 2000 se caracteriza por su lateral con panel cerrado y posee un faldón separador de bilaminado que le aporta robustez.

Euro 2000 PREMIUM incorpora opcionalmente un juego de embellecedores en los laterales, que unen los paneles con la encimera de la mesa, con piezas fabricadas en DM de color gris.

Euro 2000 is characterized by bilaminate modesty panel that gives it robustness.

Euro 2000 PREMIUM, optionally, a set of trims can be incorporated in the sides of the table, which join the panels with the countertop of the table, they are pieces manufactured in DM grey color.







DISEÑO LINEAL

SOLUCIONES
PRÁCTICAS





- ① Tapa de mesa fabricada en bilaminado de 30mm.
30 mm bilaminate table top.
- ② Laterales fabricados en bilaminado de 30 mm.
30 mm bilaminate sides.
- ③ Frontis de mesa de 19mm de espesor.
19 mm bilaminate modesty panel.
- ④ Tapa de mesa con pasacables de serie.
Grommet on the table top.
- ⑤ Cantos de pvc de 2 mm redondeado radio 2, frontis en 1 mm.
Rounded Pvc edge of table top in 2 mm radius 2, modesty panel in 1 mm.
- ⑥ Niveladores de suelo para regulación de altura.
Adjustable height with levelers.
- ⑦ Fondo de 800 mm.
Depth 800 mm.
- ⑧ Alto total 740 mm.
Height 740 mm.
- ⑨ Opción de añadir ala.
Optional side table.
- ⑩ Opción de cajonera a juego con cerradura, cajón y archivo o tres cajones.
Optional matchig drawer with lock.
- ⑪ Opción de añadir complementos de electrificación.
Optional electrification accessories.

Largo x Fondo x Alto / Length x Depth x Height

Mesa y ala / Table and wing

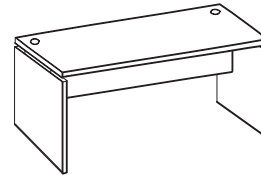

1800 x 800 x 740 mm
1600 x 800 x 740 mm
1400 x 800 x 740 mm
1200 x 800 x 740 mm

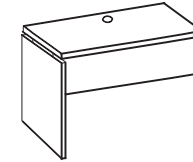

1020 x 600 x 740 mm
800 x 600 x 740 mm

* Las cajoneras son comunes a otras series > Pag: 80
The drawers are common to other series > See Page : 80

EURO 2000 PREMIUM

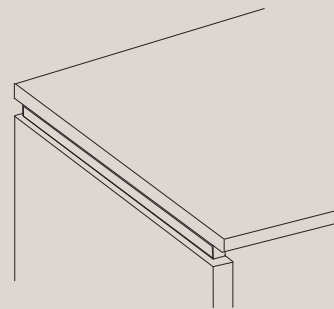

Opción de incluir un juego de embellecedores en los laterales de la mesa, que unen los paneles con la encimera de la mesa, con piezas fabricadas en DM color gris.

Option to include set of trims on the sides of the table, which join panels with countertop of table. Trims manufactured in DM gray color.

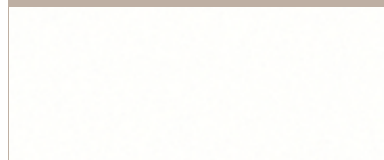

Blanco

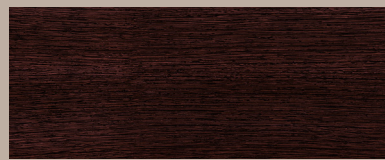

Wengué



Roble



Haya



Gris

EURO 3000

Serie operativa con un estilo clásico aunque sin renunciar a las formas del mobiliario actual. Se caracteriza por su estructura compuesta de patas metálicas y un frontis de bilaminado.

Operational series with a classic style but without renouncing the forms of the current furniture. It is characterized by its structure composed of metal legs and a bilaminate modesty panel.







Los laterales tienen patas metálicas y frontis de bilaminado que las une.
Un clásico que nunca pasa de moda. Su diseño transmite un concepto práctico en formas y en ergonomía. Las bases de las patas están equipadas con mecanismo de regulación para corregir las imperfecciones del suelo. Las tapas de mesa son de bilaminado con 30 mm de grosor.

Laterals with metallic legs and a bilaminated modesty panel that link them.
A classic that never goes out of style. Its design conveys a practical concept in shapes and in ergonomics. The legs are equipped with a regulation mechanism to levelling. Top bilaminated 30 mm thick.



- ① **Tapa de mesa fabricada en bilaminado de 30mm.**
30 mm bilaminate table top.
- ② **Laterales de mesa de metal en forma de "T" invertida y se pueden usar de pasacables.**
Sides inverted "T" shaped and we could use as grommet.
- ③ **Frontis de mesa de 19mm de espesor.**
19 mm bilaminate modesty panel.
- ④ **Tapa de mesa con pasacables de serie.**
Grommet on the table top.
- ⑤ **Cantos de pvc de 2 mm redondeado radio 2, frontis en 1 mm.**
Rounded Pvc edge of table top in 2 mm radio 2, modesty panel in 1 mm.
- ⑥ **Niveladores de suelo para regulación de altura.**
Adjustable height with levelers.
- ⑦ **Fondo de 800 mm.**
Depth 800 mm.
- ⑧ **Alto total 740 mm.**
Height 740 mm.
- ⑨ **Opción de añadir ala.**
Optional side table.
- ⑩ **Opción de cajonera a juego con cerradura, cajón y archivo o tres cajones.**
Optional matchig drawer with lock.
- ⑪ **Opción de añadir complementos de electrificación.**
Optional electrification accessories.

Largo x Fondo x Alto / Length x Depth x Height

Mesa y ala / Table and wing

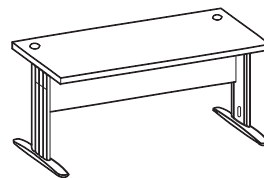

1800 x 800 x 740 mm
1600 x 800 x 740 mm
1400 x 800 x 740 mm
1200 x 800 x 740 mm

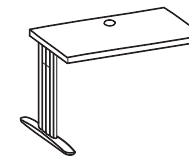

1020 x 600 x 740 mm
800 x 600 x 740 mm

* Las cajoneras son comunes a otras series > Pag: 80
The drawers are common to other series > See Page : 80



Blanco

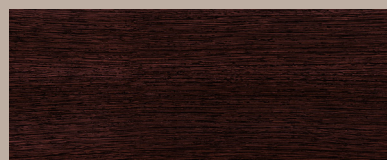

Wengué



Roble



Haya



Gris

EURO 4000

Nuestra serie más técnica. Adaptación asegurada, gracias a las vigas y bases con canalización para cables y una variada gama de referencias que le permitirán conseguir la distribución óptima.

The most technical program. Adaptation is ensured, thanks to the beams and bases with channeling of cables and a range of references that will allow you to achieve the optimal distribution.



Euro 4000 se caracteriza por sus laterales con patas metálicas y una viga electricable de metal que las une.
Es nuestra serie más técnica, todos los puestos de trabajo incorporan tapas laterales con patas metálicas en forma de T con carcasas y reguladores de altura para corregir las imperfecciones del suelo.
La serie cuenta con viga extensible de electrificación horizontal y patas con carcasas para la electrificación vertical.

Euro 4000 is characterized with metal legs and an electricable metal beam that joins them.
Our most technical program, all tables incorporate bilamine tops 30 mm thick, with lateral legs metallic as T shaped housings and height adjusters to correct imperfections.
The serie has extendable electrification and horizontal beam and legs for vertical electrification.





LIGERA
FUNCIONAL
VERSÁTIL



- ① **Tapa de mesa fabricada en bilaminado de 30mm.**
30 mm bilaminate table top.
- ② **Laterales de mesa de metal en forma de "T" invertida y se pueden usar de pasacables.**
Sides inverted "T" shaped and we could use as grommet .
- ③ **Viga telescópica de metal bajo mesa para canalizar cables.**
Telescopic metal beam under cover.
- ④ **Tapa de mesa con pasacables de serie.**
Grommet on the table top.
- ⑤ **Cantos de pvc de 2 mm redondeado radio 2, frontis en 1 mm.**
Rounded Pvc edge of table top in 2 mm radio 2, modesty panel in 1 mm.
- ⑥ **Niveladores de suelo para regulación de altura.**
Adjustable height with levelers.
- ⑦ **Fondo de 800 mm.**
Depth 800 mm.
- ⑧ **Alto total 740 mm.**
Height 740 mm.
- ⑨ **Frontis de mesa opcional en 19 mm.**
Optional 19 mm modesty panel.
- ⑩ **Opción de añadir ala.**
Optional side table.
- ⑪ **Opción de cajonera a juego con cerradura, cajón y archivo o tres cajones.**
Optional matchig drawer with lock.
- ⑫ **Opción de añadir complementos de electrificación.**
Optional electrification accessories.

Largo x Fondo x Alto / Length x Depth x Height

Mesa y ala / Table and wing

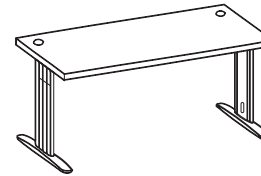

1800 x 800 x 740 mm
1600 x 800 x 740 mm
1400 x 800 x 740 mm
1200 x 800 x 740 mm

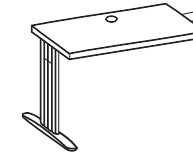

1020 x 600 x 740 mm
800 x 600 x 740 mm

* Las cajoneras son comunes a otras series > Pag: 80
The drawers are common to other series > See Page : 80

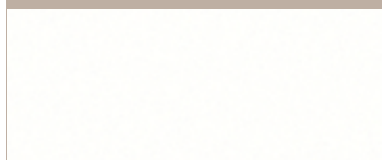

Blanco

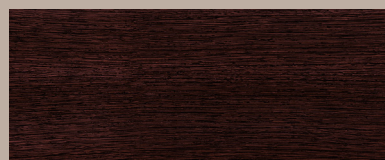

Wengué



Roble



Haya



Gris

EURO 5000

Diseño funcional pero con un alto valor estético.
Alternativa fiable con capacidad para realizar una gran variedad de configuraciones.

Functional design but with a high aesthetic value.
Reliable alternative with ability to perform a variety of configurations.







Se caracteriza por sus laterales en forma de portería con tapa elevada y viga electrificable . Ofrece configuraciones de bench para el crecimiento indefinido, mesas individuales con o sin alas. La planificación de espacios más extendida sigue siendo el sistema bench, que da cabida al crecimiento y mejora la comunicación entre departamentos o grupos de trabajo.

It's characterized with a raised top and electrificable beam. Offers of bench for indefinite growth, individual tables or with side table. The most widespread planning of spaces continues to be the bench system, which allows for growth and improves communication between departments or work groups.







- ① **Tapa de mesa fabricada en bilaminado de 30mm.**
Table top made of 30 mm bilaminate.
- ② **Laterales de mesa de metal en forma de "U" invertida.**
Sides inverted "U" shaped.
- ③ **Pletinas de elevación de tapa de acero con terminación gris.**
Steel lid lifting plates with grey finished.
- ④ **Viga telescópica de metal bajo mesa para canalizar cables.**
Telescopic metal beam under cover.
- ⑤ **Tapa de mesa con pasacables de serie.**
Grommet on the table top.
- ⑥ **Cantos de pvc de 2 mm redondeado radio 2.**
Rounded Pvc edge of table top in 2 mm radio 2.
- ⑦ **Niveladores de suelo para regulación de altura.**
Adjustable height with levelers.
- ⑧ **Fondo de 800 mm.**
Depth 800 mm.
- ⑨ **Alto total 740 mm.**
Height 740 mm.
- ⑩ **Frontis de mesa opcional en 19 mm.**
Optional 19 mm modesty panel.
- ⑪ **Opción de añadir ala.**
Optional side table.
- ⑫ **Opción de cajonera a juego con cerradura, cajón y archivo o tres cajones.**
Optional matchig drawer with lock.
- ⑬ **Opción de añadir complementos de electrificación.**
Optional electrification accessories.
- ⑭ **Opción de puestos sucesivos.**
Optional successive positions.

Largo x Fondo x Alto / Length x Depth x Height

Mesa y ala / Table and wing

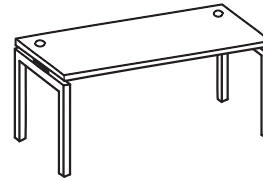

1800 x 800 x 740 mm
1600 x 800 x 740 mm
1400 x 800 x 740 mm
1200 x 800 x 740 mm

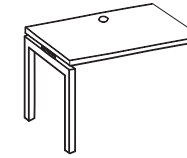

1020 x 600 x 740 mm
800 x 600 x 740 mm

* Las cajoneras son comunes a otras series > Pag: 80
The drawers are common to other series > See Page : 80

Mesas bench / Bench tables

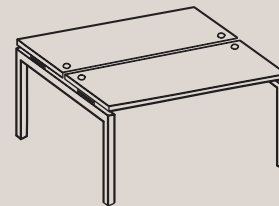

Inicial - Final
1800 x 162 x 740 mm
1600 x 162 x 740 mm
1400 x 162 x 740 mm
1200 x 162 x 740 mm

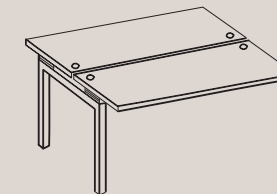

Sucesivo
1800 x 162 x 740 mm
1600 x 162 x 740 mm
1400 x 162 x 740 mm
1200 x 162 x 740 mm

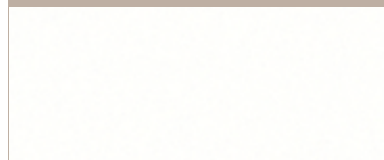

Blanco

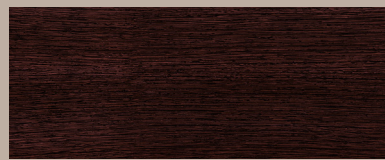

Wengué



Roble



Haya



Gris

EURO 5100

El diseño de la serie aporta ligereza visual gracias a su estructura minimalista. Puede ser instalada en despachos, puestos operativos, zonas de reunión y office.

The design of the series provides visual lightness thanks to its minimalistic structure. It can be installed in offices, operational positions, meeting zones and office.



Destaca por su ligera pero robusta estructura perimetral de acero y sus tapas bilaminadas de 30 mm que aportan máxima versatilidad y dinamismo. Su estructura perimetral y sus patas de tubo cuadrado de 40 x 40 mm permiten un uso prolongado sin que exista ningún tipo de movimiento en el conjunto.

It stands with a steel perimeter structure and its bilaminated tops of 30 mm that provide maximum versatility and dynamism. Its perimeter structure and its 40 x 40 square tube legs allow prolonged use without movement in the set.







- ① **Tapa de mesa fabricada en bilaminado de 30 mm.**
30 mm bilaminate table top.
- ② **Canto redondeado en 2 mm.**
Rounded edge in 2 mm.
- ③ **Estructura perimetral de tubo metálico, color gris (RAL 9006)**
Perimeter structure of metal tube, grey color (RAL 9006).
- ④ **Patas de tubo de metal de 40 x 40 mm.**
40 x 40 mm metal legs.
- ⑤ **Tapa de mesa con pasacables de serie.**
Grommet on the table top.
- ⑥ **Cantos de pvc de 2 mm redondeado radio 2.**
Rounded Pvc edge of table top in 2 mm radio 2.
- ⑦ **Niveladores de suelo para regulación de altura.**
Adjustable height with levelers.
- ⑧ **Fondo de 800 mm.**
Depth 800 mm.
- ⑨ **Alto total 740 mm.**
Height 740 mm.
- ⑩ **Frontis de mesa opcional en 19 mm.**
Optional 19 mm modesty panel.
- ⑪ **Opción de añadir ala.**
Optional side table.
- ⑫ **Opción de cajonera a juego con cerradura, cajón y archivo o tres cajones.**
Optional matchig drawer with lock.
- ⑬ **Opción de añadir complementos de electrificación.**
Optional electrification accessories.

Largo x Fondo x Alto / Length x Depth x Height

Mesa y ala / Table and wing

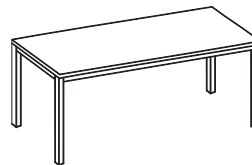

2000 x 800 x 740 mm
1800 x 800 x 740 mm
1600 x 800 x 740 mm
1400 x 800 x 740 mm
1200 x 800 x 740 mm

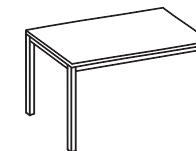

1020 x 600 x 740 mm
800 x 600 x 740 mm

* Las cajoneras son comunes a otras series > Pag: 80
The drawers are common to other series > See Page : 80

Producto certificado por:



Blanco

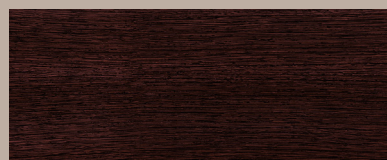

Wengué



Roble



Haya



Gris

MESAS DE REUNIÓN

Las mesas de reuniones de formas simples pero estructuras compactas, nos ayudan a crear entornos más dinámicos facilitando el trabajo en equipo.

Meeting tables with simple shapes but compact structures help us to create more dynamic environments facilitating teamwork.





- ① **Tapas de mesa fabricadas en bilaminado de 30 mm.**
Table top made of 30 mm bilaminate.
- ② **Cantos de pvc de 2 mm redondeado radio 2.**
Rounded Pvc edge of table top in 2 mm radio 2.
- ③ **Bases en X fabricadas en bilaminado de 30 mm.**
X bases in 30mm bilaminate.
- ④ **Bases en H fabricadas en bilaminado de 30 mm y frontis 19 mm.**
H bases in 30mm bilaminate and modesty panel of 19mm.
- ⑤ **Bases circular con tubo metálico gris, blanco o cromado.**
Circular bases with metal tube in grey, white and chrome.
- ⑥ **Bases cuadrada con tubo cromado.**
Square bases with metal tube in chrome.
- ⑦ **Disponible en diversos tamaños.**
Available in different sizes.
- ⑧ **Modular con diversas posibilidades de forma .**
Modular with many possibilities about form.
- ⑨ **Opción de añadir complementos de electrificación.**
Optional electrification accessories.

Largo x Fondo x Alto / Length x Depth x Height

Mesas Reunión Euro / Euro Series



1200 Ø x 740 mm
1000 Ø x 740 mm

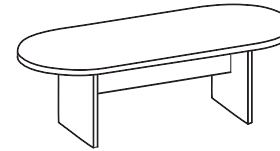

2400 x 1000 x 740 mm
2000 x 900 x 740 mm

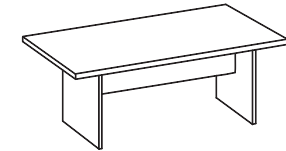

2400 x 1000 x 740 mm
2000 x 1000 x 740 mm

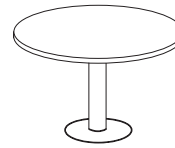

1200 Ø x 740 mm
1000 Ø x 740 mm

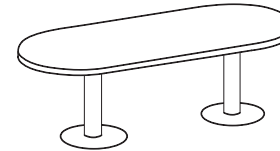

2400 x 1000 x 740 mm
2000 x 900 x 740 mm

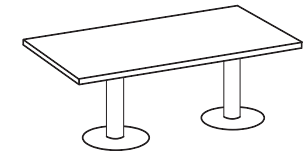

2400 x 1000 x 740 mm
2000 x 1000 x 740 mm

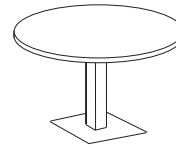

1200 Ø x 740 mm
1000 Ø x 740 mm

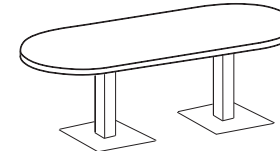

2400 x 1000 x 740 mm
2000 x 900 x 740 mm

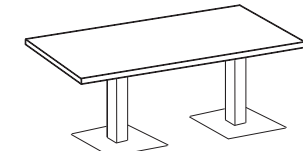

2400 x 1000 x 740 mm
2000 x 1000 x 740 mm

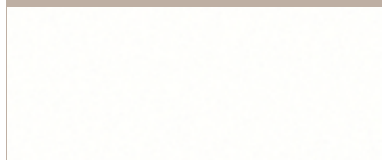

Blanco

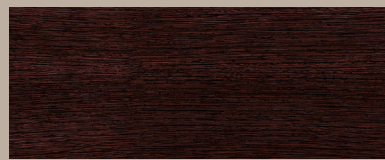

Wengué



Roble



Haya



Gris



BUCK ATENAS

Bucks rodantes funcionales para almacenaje diario y con capacidad de potenciar la ergonomía del puesto de trabajo.
Diferentes soluciones en metal o bilaminado.

Functional rolling bucks for daily storage and with the ability to enhance the ergonomics of the workplace.
Different solutions in metal or bilaminate.

BUCK EURO



Largo x Fondo x Alto / Length x Depth x Height

SERIE ATENAS (METAL) :

- ① Estructura de acero pintado (blanco o plata).
Painted steel structure (white or silver).
- ② Tirador oculto y apertura de cajón 100%.
Hidden handle and drawer opening 100%.
- ③ Cerradura con mecanismo antivuelco.
Lock with no tilt mechanism.
- ④ Ruedas con freno.
Wheels with brake.
- ⑤ Altura 550 mm.
Height 550 mm.

Buck Atenas (Metal) / Buck Atenas



400 x 540 x 550 mm



400 x 540 x 550 mm

* Opcional: Se puede añadir encimera de bilaminado de 19 mm. Terminaciones Euro.
Optional: 19 mm bilaminate worktop can be added. Terminations Euro.

SERIE EURO (BILAMINADO) :

- ① Encimera y laterales en bilaminado de 30mm.
Top table and sides of bilaminate de 30mm.
- ② Base en bilaminado de 19 mm.
19mm bilaminate base.
- ③ Trasera en bilaminado de 10 mm.
10 mm bilaminate rear.
- ④ Cerradura de bloqueo que afecta a todos los cajones y archivo.
Lock that affects all drawers and file.
- ⑤ Ruedas con freno.
Wheels with brake.
- ⑥ Altura 580 mm.
Height 580 mm.

Buck Euro (bilaminado) / Buck Euro



400 x 540 x 580 mm



400 x 540 x 580 mm

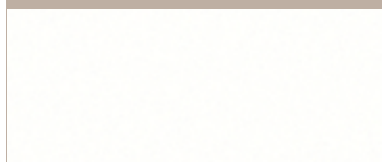

Blanco



Wengué



Roble



Haya



Gris

ARMARIOS OPERATIVOS

Armarios robustos y resistentes, con herrajes y componentes de calidad.
Gran variedad de modelos y combinaciones que se adaptan a cualquier entorno de oficina.

Robust and resistant cabinets, with quality fittings and components.
Wide variety of models and combinations that adapt to any office environment.





- ① Encimera de bilaminado de 30mm.
30 mm bilaminate worktop.
- ② Trasera de bilaminado de 10mm.
10 mm bilaminate rear.
- ③ Laterales, suelo y puertas de bilaminado en 19 mm.
Sides, floor and doors bilaminate 19 mm.
- ④ Cerradura metálica con falleba en puertas verticales de bilaminado.
Metallic lock with bolts on vertical bilaminate doors.
- ⑤ Puertas de cristal matizado sin marco de 6 mm.
6 mm tinted glass doors without frame.
- ⑥ Bisagras automáticas, provistas de regulación.
Automatic hinges, equipped with regulation.
- ⑦ Canto de tapa redondeado en radio 2 mm.
Rounded edge of table top in 2 mm.
- ⑧ Canto puertas y frentes de archivo redondeado en radio 1 mm.
Rounded edge of doors in 2 mm.
- ⑨ Cuatro niveladores de suelo en cada armario.
Four floor levelers in each cup board.
- ⑩ Disponible en tres tamaños de altura.
Available in three sizes.
- ⑪ Largo total 740, 920 o 1500 mm.
Length 740, 920 or 1500 mm.
- ⑫ Fondo de 420 mm.
Length 920 or 1500 mm.
- ⑬ Dos opciones de estantes: Normal con 19 mm o sobrecarga con 30 mm.
Two options of shelves: Normal with 19 mm or overload with 30 mm.
- ⑭ Opción de añadir tirador cromado.
Optional chrome handle.
- ⑮ Opción de añadir soporte fijo o telescópico para carpetas.
Option to add permanent or telescopic support for folders.

Largo x Fondo x Alto / Length x Depth x Height

Armarios / Wardrobe

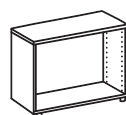

920 x 420 x 740 mm

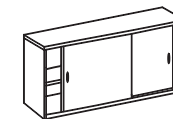
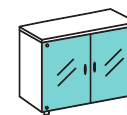
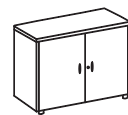

1500 x 420 x 740 mm

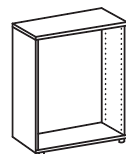

920 x 420 x 1400 mm

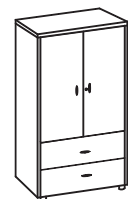
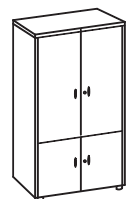
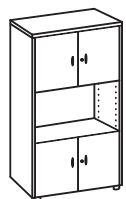
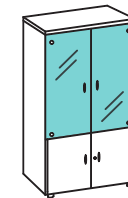
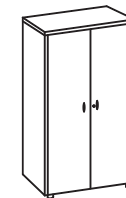
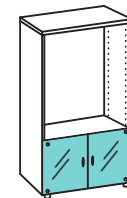
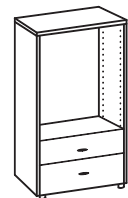
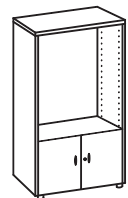
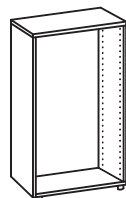
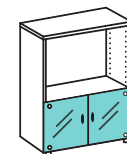
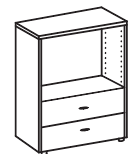

920 x 420 x 2060 mm

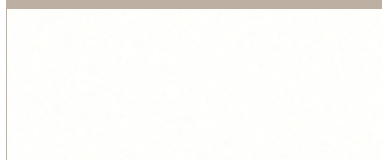

Blanco

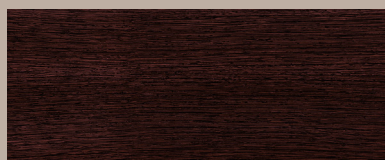

Wengué



Roble



Haya



Gris

MESAS MULTIFUNCIÓN



Sencillas y adaptables. Una solución práctica para espacios colectivos que requieran robustez y facilidad de movimiento. Ideal para academias, salas de formación, espacios de reunión y office.

Simple and adaptable. A practical solution for collective spaces that require robustness and ease of movement. Ideal for academies, training rooms, meeting and office spaces.

- ① **Tapa de mesa fabricada en bilaminado de 30 mm.**
Table top made of 30 mm bilaminate.
- ② **Canto redondeado en 2 mm.**
Rounded edge in 2 mm.
- ③ **Cuatro patas cilíndricas en tubo metálico de 60 mm .**
Four cylindrical legs of 60 mm metal tube.
- ④ **Cuatro niveladores de suelo en cada pata.**
Adjustable height on each leg.
- ⑤ **Fondo de 700 o 800 mm.**
Depth 700 or 800 mm.
- ⑥ **Alto total 740 mm.**
Height 740 mm.
- ⑦ **Patas opcionales en gris o negro.**
Legs come in grey or black.
- ⑧ **Opción de añadir complementos de electrificación.**
Optional electrification accessories.

Largo x Fondo x Alto / Length x Depth x Height

Mesas Tables

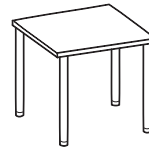

800 x 800 x 740 mm
700 x 700 x 740 mm

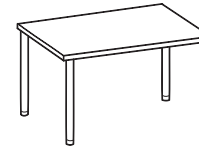

1600 x 800 x 740 mm
1400 x 700 x 740 mm

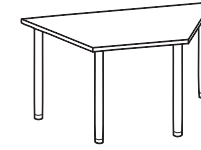

1400 x 700-700 x 740 mm

* Consultar otras dimensiones de mesa.
Consult other table dimensions.

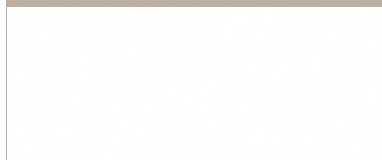

Blanco

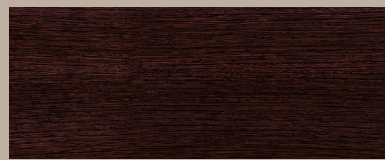

Wengué



Roble



Haya



Gris

TELEMARKETING



- ① **Tapa de mesa fabricada en bilaminado de 30mm.**
Table top made of 30 mm bilaminate.
- ② **Laterales fabricados en bilaminado de 30 mm.**
Sides made of 30 mm bilaminate.
- ③ **Traseras fabricadas en bilaminado de 19 mm.**
Backs manufactured in 19 mm bilaminate.
- ④ **Canto de PVC redondeado en 2 mm.**
Rounded edge of PVC in 2 mm.
- ⑤ **Cuatro niveladores de suelo.**
Four floor levelers.
- ⑥ **Fondo de 620 mm.**
Depth 620 mm.
- ⑦ **Alto total 1240 mm.**
Height 1240 mm.
- ⑧ **Opción de separador de vidrio de 8 mm.**
Option of 8 mm glass separator.

Largo x Fondo x Alto / Length x Depth x Height

Módulos / Modules

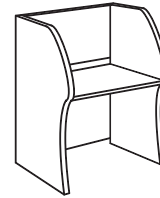

860 x 620 x 1240 mm

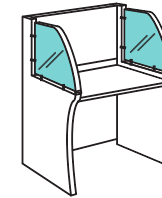

860 x 620 x 1240 mm

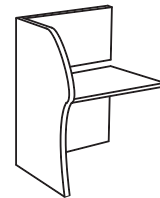

830 x 620 x 1240 mm

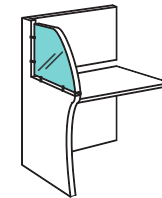

830 x 620 x 1240 mm

Siempre módulos iniciales o individuales (con dos laterales)
que se prolongan con módulos sucesivos (con un lateral).
El resultado es un completo sistema de telecabinas con espacio para
paso de cables en la trasera y laterales elevados para un mayor aislamiento.

It always starts with initial or individual modules (with two laterals) with successive modules (with one lateral).
The result is a complete telemarketing places system with open rear for cables and high sides for greater insulation

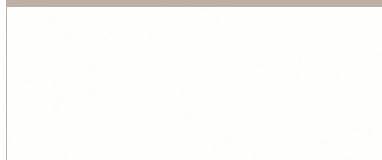

Blanco

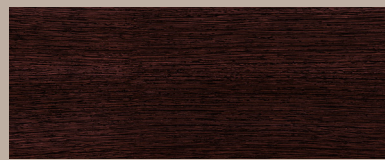

Wengué



Roble



Haya



Gris



euromof.com



+34 91 534 31 54



euromof@euromof.com



Showroom: C/ Quintana 10, 28008, Madrid



Factory: Calle "C" Naves 43-44, Cedillo del Condado, 45214, Toledo

Euromof
la fábrica de muebles de oficina